



lead forming machines

selective soldering machines

special machines



Internet: <http://www.ebso.com>



EBSOMAT 400

To check if your requirements are possible to do on the E400 please provide us with the following specs.

A drawing of the component

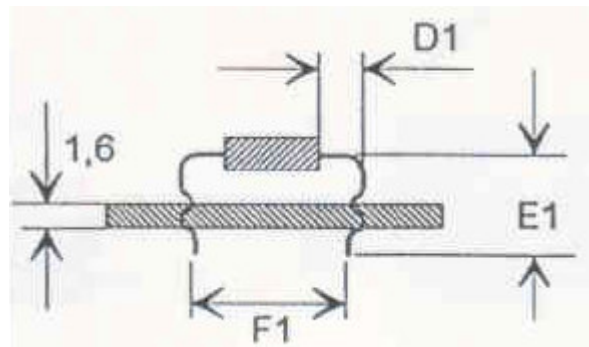
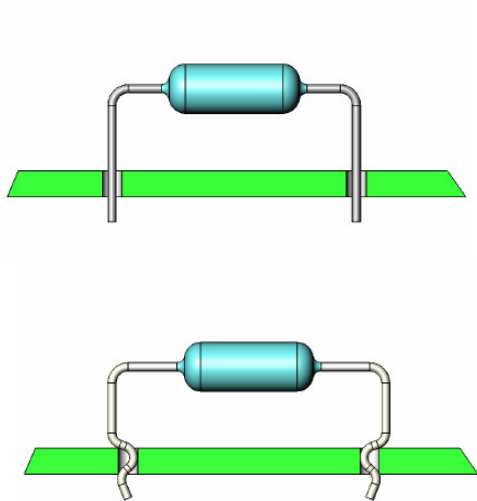

PCB-Thickness Standard = 1,6 mm
Please specify if your PCB has different size

Lead Diameter and component specs

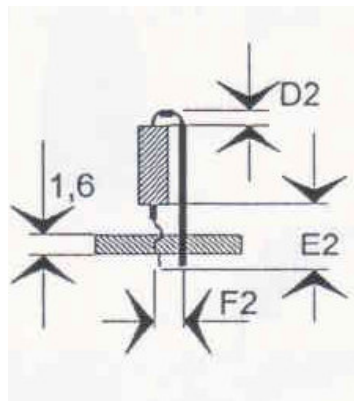
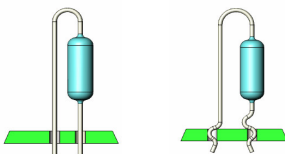
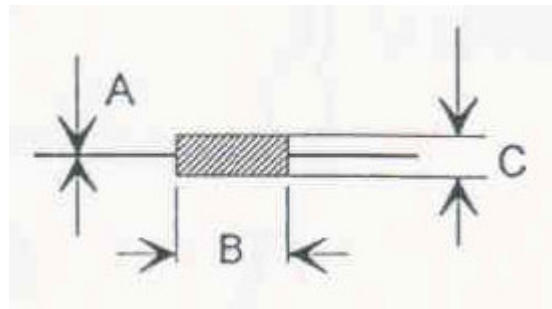



lead forming machines

selective soldering machines

special machines



Internet: <http://www.ebso.com>

Specs to belt

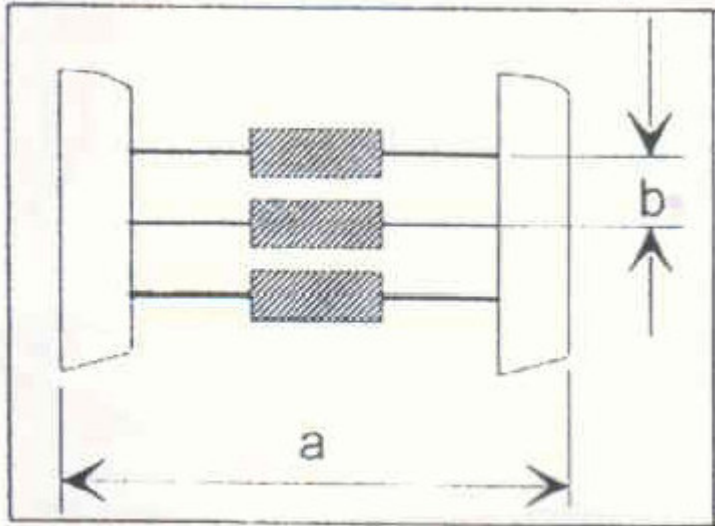



lead forming machines

selective soldering machines

special machines



Internet: <http://www.ebso.com>



Following some samples of possible toolings on E400

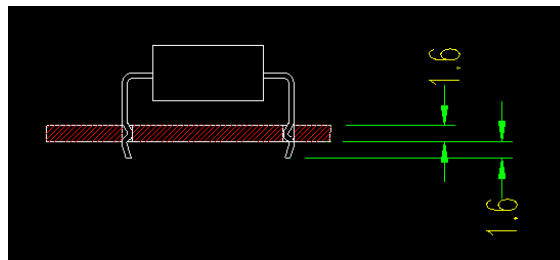

4-001

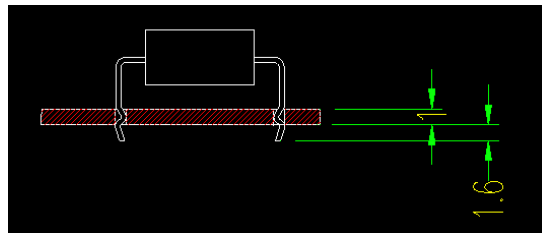

4-011

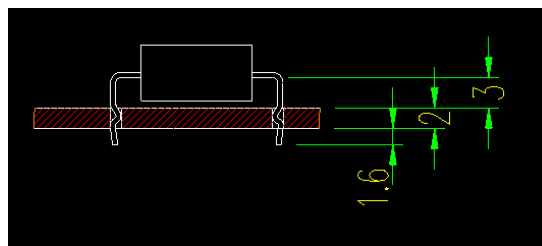

4-066





lead forming machines

selective soldering machines

special machines

EBSO

Internet: <http://www.ebso.com>

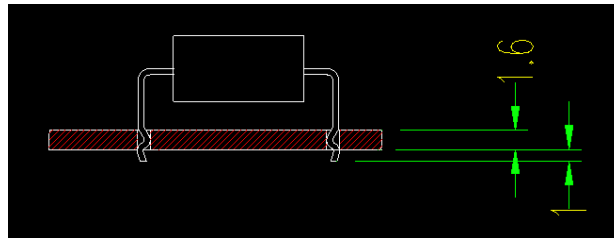

4-026

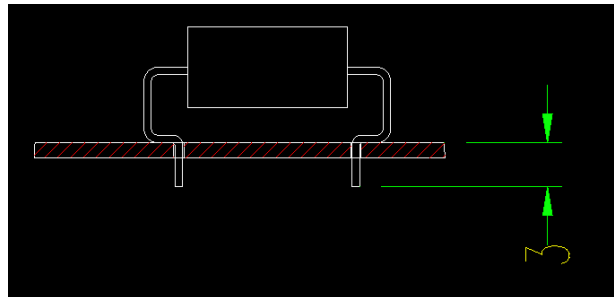

4-006

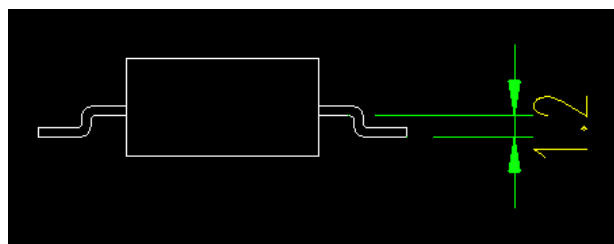

4-006





lead forming machines

selective soldering machines

special machines



Internet: <http://www.ebso.com>

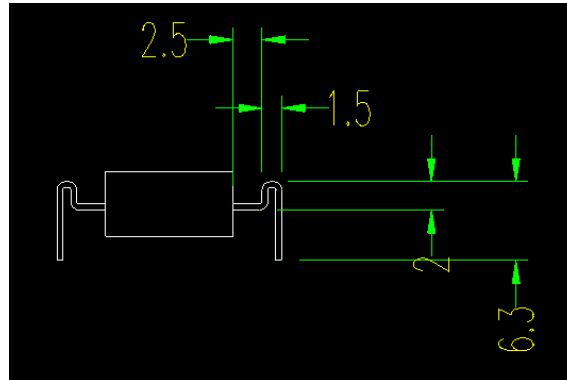

4-046

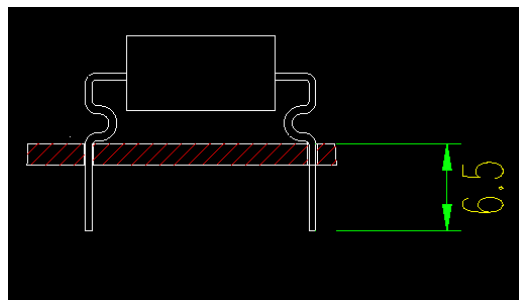

4-059

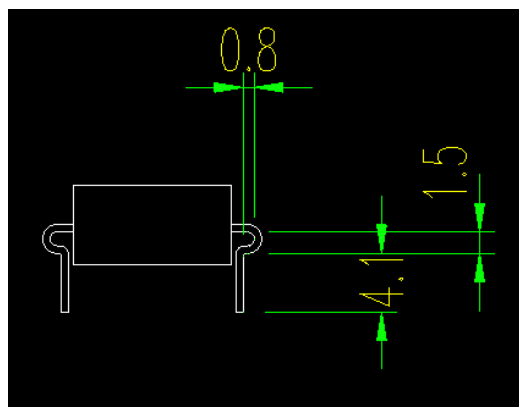

4-067

